



extreme arcade™

Owner's Manual



CHICAGO GAMING COMPANY

4616 W. 19th Street, Cicero, IL 60804 (800)379-9776



(Rev. 1.1)

EXTREME ARCADE™

Thank you for purchasing Chicago Gaming Company's *Extreme Arcade*. You can look forward to many hours of video game enjoyment. We strongly recommend that you follow the instructions and procedures as presented in this Owner's Manual and that it be read in its entirety before setting up your game.

1. IMPORTANT SAFETY INSTRUCTIONS

- Read these instructions.
- Keep these instructions.
- Heed all warnings.
- Follow all instructions.
- Do not use this apparatus near water.
- Clean only with a dry cloth.
- Do not block any ventilation openings. Install in accordance with manufacturer's instructions.
- Do not install near any heat sources such as radiators, heat registers, stoves, or other apparatus (including amplifiers) that produce heat.
- Do not defeat the safety purpose of the polarized or grounding-type plug. A polarized plug has two blades with one wider than the other. A grounding type plug has two blades and a third grounding prong. The wide blade and third prong are provided for your safety. If the provided plug does not fit into your outlet, consult an electrician for replacement of the obsolete outlet.
- Protect the power cord from being walked on or pinched, particularly at plugs, convenience receptacles and the point where they exit from the apparatus.
- Only use attachments/accessories specified from the manufacturer.
- Unplug this apparatus during lightning storms or when unused for long periods of time.
- Refer all servicing to qualified service personnel. Servicing is required when the apparatus has been damaged in any way, such as power supply cord or plug is damaged, liquid has been spilled or objects have fallen into the apparatus, the apparatus has been exposed to rain or moisture, does not operate normally, or has been dropped.

 <p>THE LIGHTNING FLASH AND ARROWHEAD WITHIN THE TRIANGLE IS A WARNING SIGN ALERTING YOU OF "DANGEROUS VOLTAGE" INSIDE THE PRODUCT.</p>	 <p>CAUTION RISK OF ELECTRIC SHOCK DO NOT OPEN. REFER SERVICING TO SERVICE PERSONNEL.</p> <p>CAUTION: TO REDUCE THE RISK OF ELECTRIC SHOCK, DO NOT REMOVE COVER (OR BACK). NO USER SERVICEABLE PARTS INSIDE. REFER SERVICING TO QUALIFIED SERVICE PERSONNEL.</p>	 <p>THE EXCLAMATION POINT WITHIN THE TRIANGLE IS A WARNING SIGN ALERTING YOU OF IMPORTANT INSTRUCTIONS ACCOMPANYING THE PRODUCT.</p>
<p>SEE MARKINGS ON PRODUCT</p>		

CAUTION: Shock hazard if instructions are not followed.

- **WARNING:** To reduce the risk of fire or electric shock do not expose your system to rain or moisture.
- **WARNING:** An apparatus with Class I construction shall be connected to a main socket outlet with a protective earthing connection.
- Be sure to disconnect the power cable before working on the machine.
- Be sure to use fuses which meet the specified rating. (5A, 220V Quick-blow).
Using fuses exceeding the specified rating can cause a fire and electrical shock.
- **CAUTION:** The game's monitor is a source of high voltage. Be EXTREMELY CAREFUL when working near it; high voltage charges can still be present even after you've unplugged the unit. **Have a qualified technician perform a monitor repair.**
- Optimum operating environment is between 50-105° Fahrenheit.
- Use with only 115 volts ~ 60Hz
- We recommend using a surge suppresser or UPS (Uninterruptible Power Supply) to safeguard the game from abrupt power spikes or losses

2. ATARI END USER LICENSE AGREEMENT

By accepting and operating an *Extreme Arcade*, the owner (“**End User**”) of the unit agrees to abide by the terms of this agreement. Asteroids, Asteroids Deluxe, Atari Basketball, Battlezone, Black Widow, Centipede, Cloak and Dagger, Crystal Castles, Food Fight, Gravitar, Liberator, Lunar Lander, Millipede, Missile Command, Pong, Red Baron, Skydiver, Space Duel, Super Break-Out, Tempest, Video Pinball, Warlords and related logos are used under license from Atari Interactive, Inc. (“**Atari**”). Atari expressly reserves the sole and exclusive ownership of the aforementioned games and all rights relating thereto. The end user hereby acknowledges that Atari is the sole and exclusive owner of the games and licensed trademarks and agrees not to challenge at any time, directly or indirectly, the rights of Atari. The end user agrees not to attempt to copy the licensed property (in whole or in part), decompile, disassemble or otherwise reverse engineer the software in any way. Atari is a third party beneficiary to this agreement and retains the right to bring action directly against an End User for breach of this End User License Agreement.

3. WARRANTY INFORMATION

Extreme Arcade is warranted against manufacturing defects for 180 days. After that we will provide free telephone support. If at some point you require warranty service, contact Chicago Gaming at (800)379-9776. Ask for technical support.



4. GAME SETUP



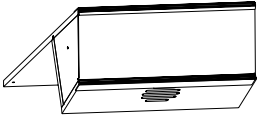
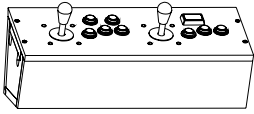
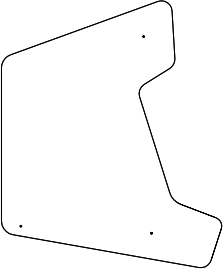
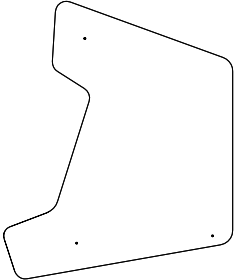
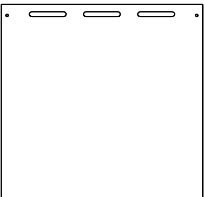
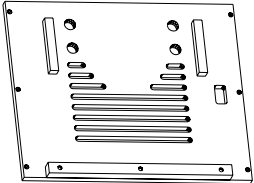
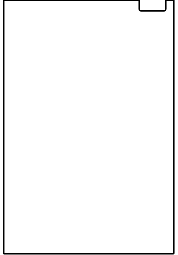

4.1 INSTALLATION

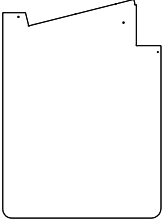
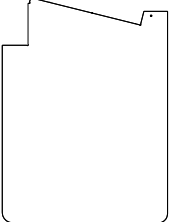
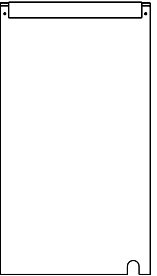
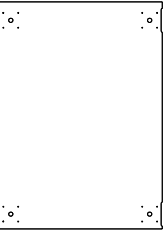
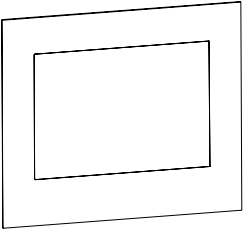
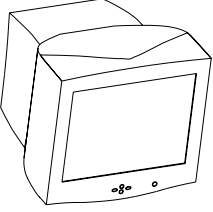
- Remove the components from their packaging. Confirm all items listed in the **Parts List** (see pages 4 through 6) are present.
- When moving the unit, please treat it as delicately as possible. The monitor is fragile.
- Be sure to install it in a dry location.
- Plug the machine into a three-prong A/C outlet.
- Please note, the monitor may initially appear discolored, particularly in the monitor's corners. This discoloration will go away after it has been powered up a number of times. You will have to let the unit return to room temperature after each power cycle for the monitor's degaussing circuit to clear up this discoloration.

4.2 Parts List

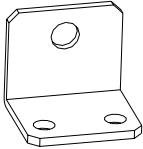
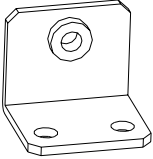
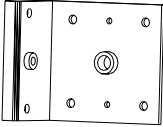
	Description	Part #	Quantity
	<p>Lightbox Assembly</p>	<p><i>A1</i></p>	<p>1</p>
	<p>Control Panel Assembly</p>	<p>A2</p>	<p>1</p>
	<p>Top Left</p>	<p>C1</p>	<p>1</p>
	<p>Top Right</p>	<p>C2</p>	<p>1</p>
	<p>Top Back</p>	<p>C3</p>	<p>1</p>
	<p>Monitor Shelf</p>	<p>C4</p>	<p>1</p>
	<p>Base Front</p>	<p>C5</p>	<p>1</p>

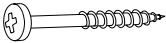
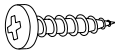
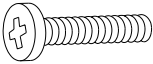
	Left Base Side	C6	1
	Right Base Side	C7	1
	Base Back	C8	1
	Bottom	C9	1
	Monitor Glass	C10	1
	Monitor	E1	1
	A/C Cord	E2	1

	Standard Angle Bracket (Silver)	H1	16
	Threaded Angle Bracket (Gold)	H2	10
	Leg Side Bracket	H3	4
	Leg Leveler	H4	4
	#6 x 1-1/4" Wood Screw	H5	6
	#10 x 1/2" Wood Screw	H6	76
	#10-32 x 1-1/4" Truss Head Screw	H7	24
	Nylon Washer	H8	6
	Cable Clamp	H9	1

End of Parts List

4.3 Preassembly

Please find all the parts shown below in this section [C1, C2, C5, C6, C7, C9, H1 and H2]. You will see a series of pilot holes (small holes drilled only 1/4" into the wood) on each part shown below. Align the appropriate bracket (H1 or H2 as indicated below) with the pilot holes. Screw two screws [H6] through the bracket [H1 or H2] into the pilot hole in the wood. It will be easier to align the second screw if you don't tighten the first screw all the way down before starting the second screw.

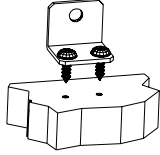

(H1) Standard Angle Bracket (Silver)

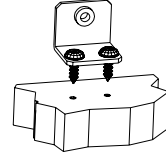

(H2) Threaded Angle Bracket (Gold)

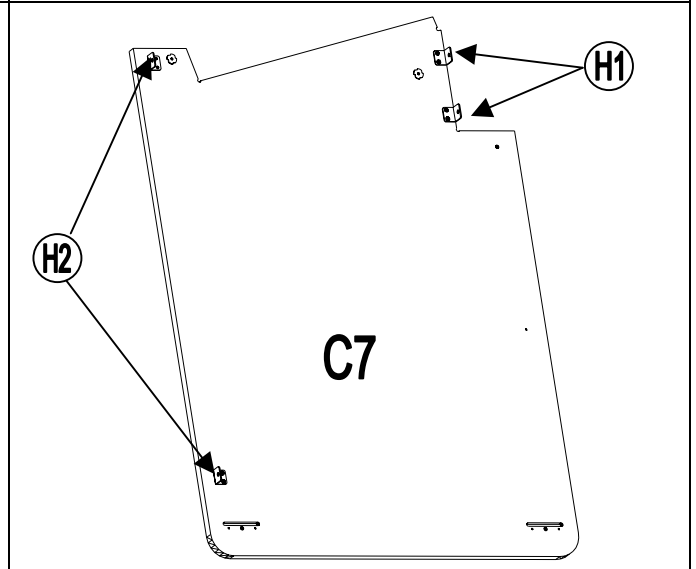
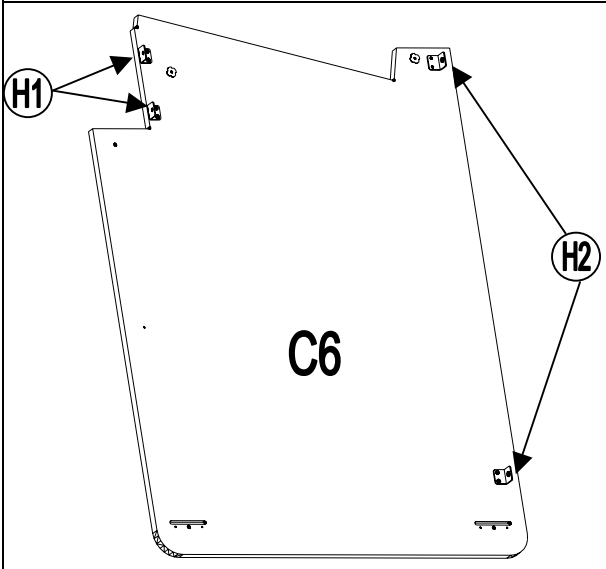
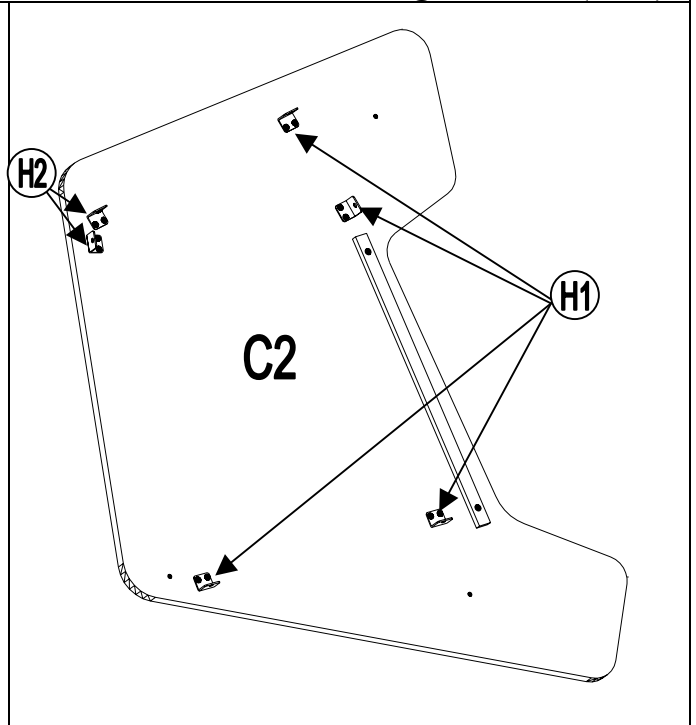
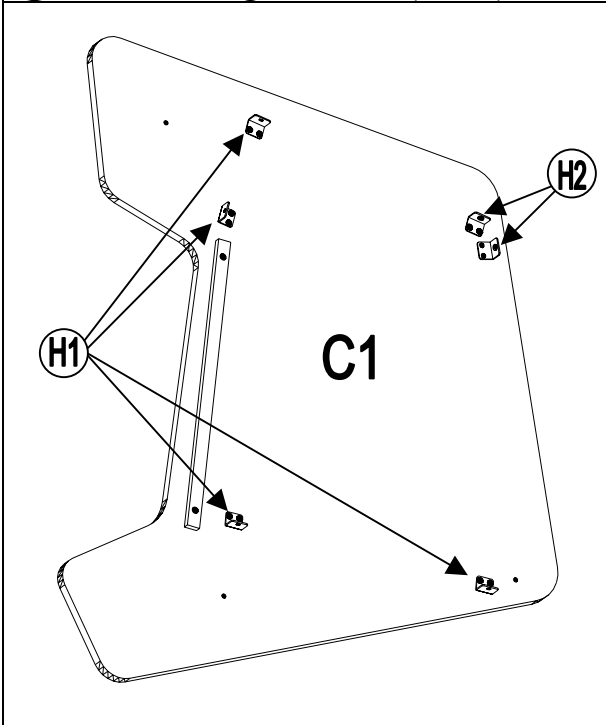

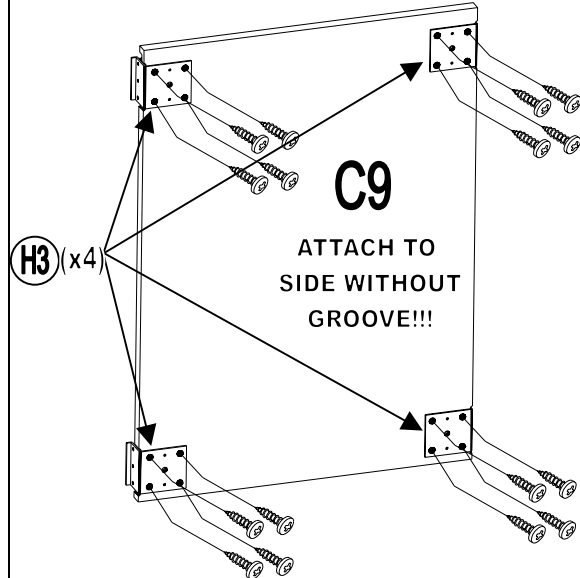
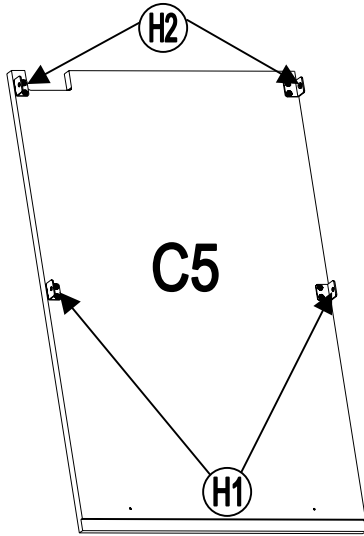

Attach **H3 Leg Side Bracket** to **C9 Bottom** using (4X4) **H6 #10 x 1/2" Wood Screws** to secure each part. **NOTE: BE SURE TO ATTACH H3 Leg Side Bracket TO THE TOP (SIDE WITHOUT THE GROOVE).**

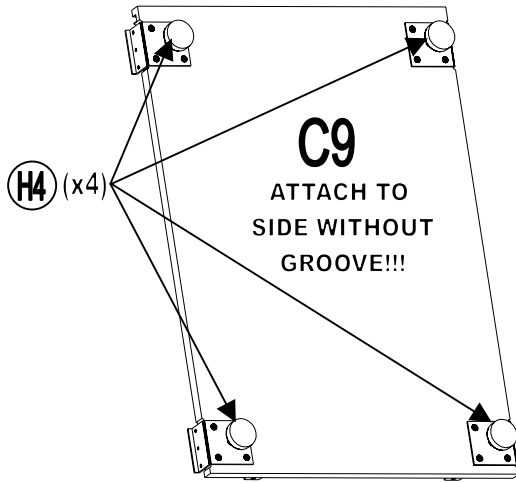

Screw **H4 Leg Leveler** into **H3 Leg Side Bracket**. Leave approximately one inch of thread showing on the side with the Leg Leveler.

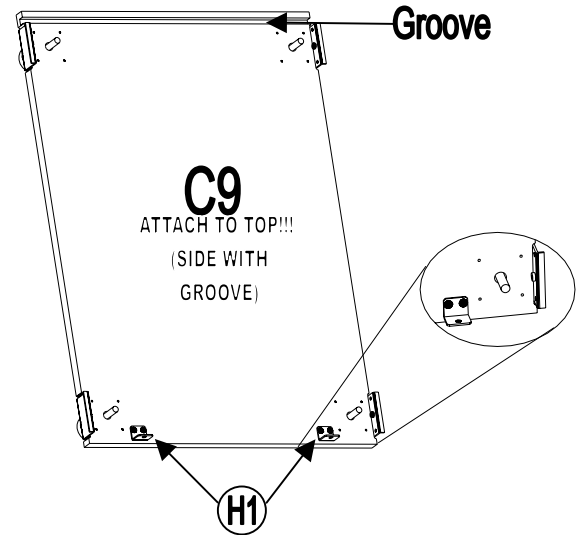

Attach **H1 Standard Angle Bracket** to **C9 Bottom** using four **H6 #10 x 1/2" Wood Screws**. **NOTE: BE SURE TO ATTACH TO THE SIDE WITH THE GROOVE. DO NOT MOUNT H1 STANDARD ANGLE BRACKET IN THE PILOT HOLES FOR H3 LEG SIDE BRACKET.**

4.4 Assembly Instructions

Step 1

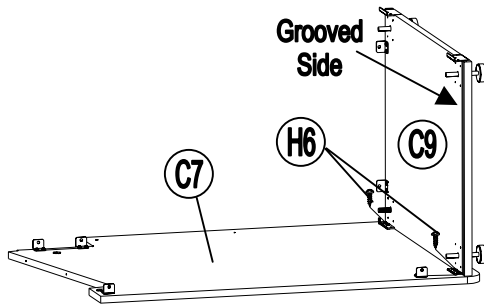

Lay **C7 Right Base Side** on any flat surface; including, a workbench, table or the floor. Place **C9 Bottom** perpendicular to **C7 Right Base Side**. **BE SURE TO ORIENT THE GROOVED SIDE OF C9 IN THE PROPER DIRECTION**. Align the protruding metal tab in **H3 Leg Side Bracket** into the slots at the bottom of **C7 Right Base Side**. Further align the hole in **H3 Leg Side Bracket** with the pilot holes in **C7 Right Base Side** and secure with **H6 #10 x 1/2" Wood Screw**. Only one **H6 #10 x 1/2" Wood Screw** is needed to secure each **H3 Leg Side Bracket**.

Step 2

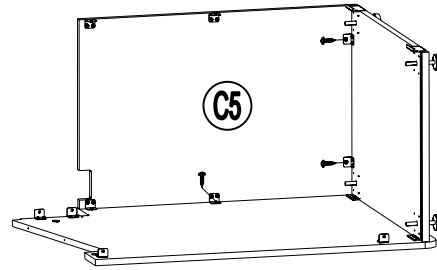

Place **C5 Base Front** in the progressing assembly. Align the holes in the brackets with the appropriate pilot holes and secure with three **H6 #10 x 1/2" Wood Screw**.

Step 3

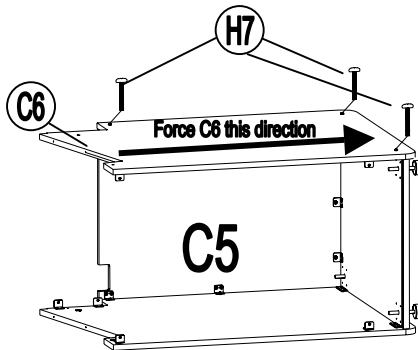

Place **C6 Left Base Side** on the progressing assembly. Align the holes located in **C6 Left Base Side** with **H3 Leg Side Bracket** and **H2 Treaded Angle Bracket** and secure with **H7 #10-32 x 1-1/4" Truss Head Screw**. Before tightening screws, force **C6 Left Base Side** toward the floor side of the assembly.

Step 4

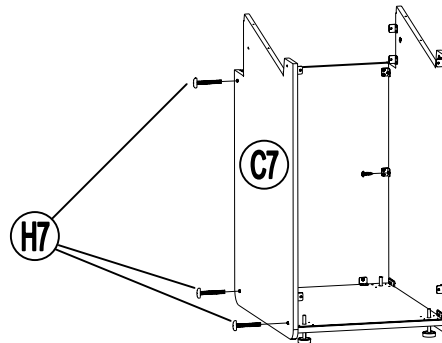

Place the assembly in its upright position on the floor. Adjust **H4 Leg Leveler** to a height that keeps the sides of the assembly off the ground. Screw **H7 #10-32 x 1-1/4" Truss Head Screw** through **C7 Right Base Side** into **H3 Leg Side Bracket**.

Step 5

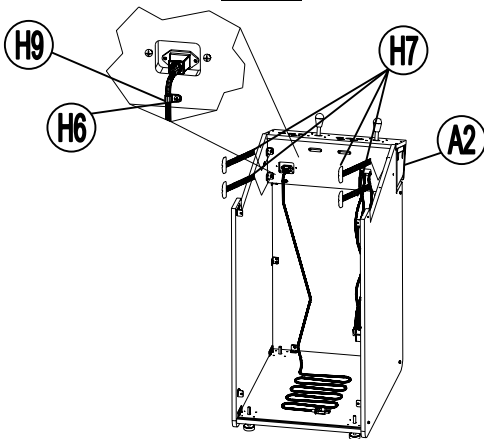

Place **A2 Control Panel Assembly** onto the progressing assembly and secure with **H7 #10-32 x 1-1/4" Truss Head Screws**. Make sure **A2 Control Panel Assembly** is centered in the progressing assembly. Attach **H9 Cable Clamp** to **A2 Control Panel Assembly** with **H6 #10 x 1/2" Wood Screw**. This will secure the power cord from coming unplugged from **A2 Control Panel Box**.

Step 6

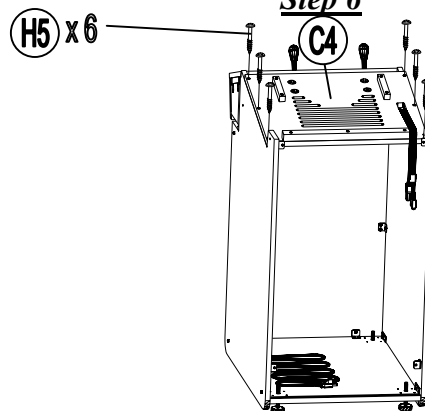

Place **C4 Monitor Shelf** onto the progressing assembly. Use **C4 Monitor Shelf** to confirm the progressing assembly is square. If the progressing assembly is not square, you may need to slightly loosen the **H7 #10-32 x 1-1/4" Truss Head Screws** that were previously utilized and then force assembly square. Once the progressing assembly is square, insert **H5 #6 x 1-1/4" Wood Screw** through **C4 Monitor Shelf** into the pilot holes in **C6 Left Base Side** and **C7 Right Base Side** and tighten down. **BE CERTAIN SCREWS ENTER THE PILOT HOLES**.

TAKE GREAT CARE NOT TO PINCH ELECTRICAL WIRES AND CORDS. IF ELECTRICAL WIRES OR CORDS ARE INADVERTENTLY DAMAGED, DO NOT USE THEM! CONTACT MANUFACTURER FOR REPLACEMENT.

TAKE GREAT CARE NOT TO PINCH ELECTRICAL WIRES AND CORDS. IF ELECTRICAL WIRES OR CORDS ARE INADVERTENTLY DAMAGED, DO NOT USE THEM! CONTACT MANUFACTURER FOR REPLACEMENT.

Step 7

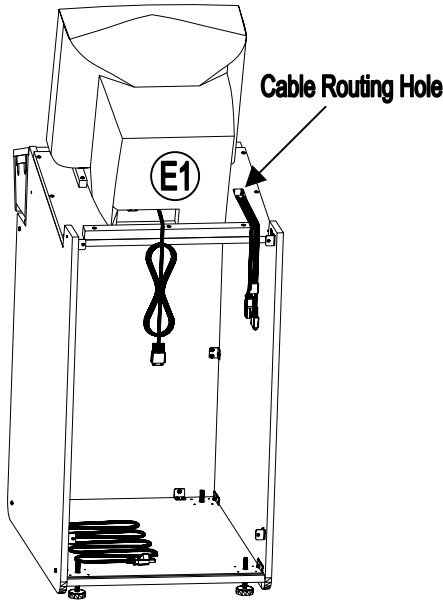

Remove **E1 Monitor** from its box and place it on the progressing assembly. The monitor should be centered between the two cleats and pushed all the way to the back of the game. Pull the monitor **A/C Cable**, **VGA Cable** and **Speaker/Lamp Cable** through the **Cable Routing Hole** in **C4 Monitor Shelf**.

TAKE GREAT CARE NOT TO PINCH ELECTRICAL WIRES AND CORDS. IF ELECTRICAL WIRES OR CORDS ARE INADVERTENTLY DAMAGED, DO NOT USE THEM! CONTACT MANUFACTURER FOR REPLACEMENT.

Step 8

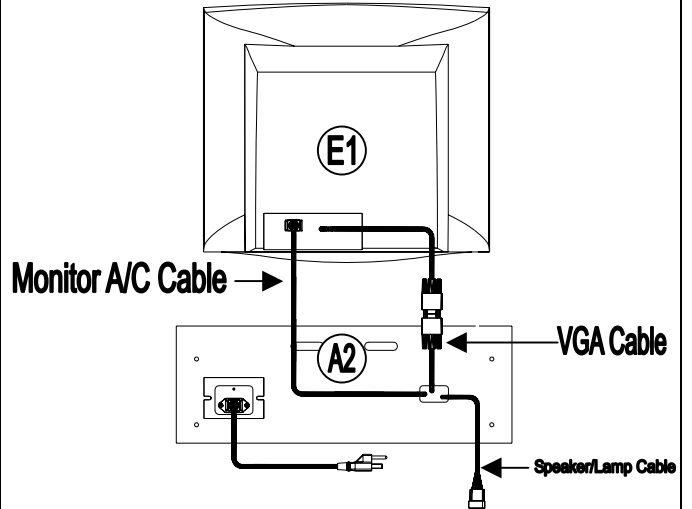

Connect the **Monitor A/C Cable**, which extends from **A2 Control Panel Assembly** to the back of the monitor. Connect the **VGA Cable**, which extends from **A2 Control Panel Assembly** to the VGA cable extending from the back of the monitor. Plug **E2 A/C Cord** into the back of **A2 Control Panel Assembly**. Temporarily plug the A/C cable into your wall outlet. Turn the power switch on (located at the front, bottom right side of the control panel assembly). Confirm system powers up. If monitor does not turn on, press power button on the monitor. Following the instructions included with the monitor, center the image and set brightness to 75 (or whatever setting looks best to you). After you have adjusted the monitor, unplug the unit from the wall.

TAKE GREAT CARE NOT TO PINCH ELECTRICAL WIRES AND CORDS. IF ELECTRICAL WIRES OR CORDS ARE INADVERTENTLY DAMAGED, DO NOT USE THEM! CONTACT MANUFACTURER FOR REPLACEMENT.

Step 9

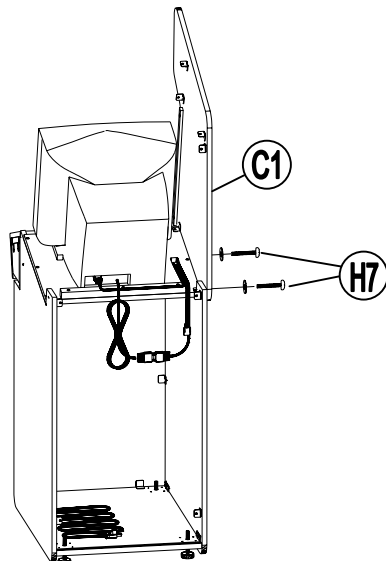

Set **C1 Top Left** on the progressing assembly. The four **H1 Standard Angle Brackets** located on **C1 Top Left** are there only to help position the part while you install **H7 #10-32 x 1-1/4" Truss Head Screws** (no screws will pass through the open holes in the four **H1 Standard Angle Brackets**). Be sure to use **H8 Nylon Washer** on the screws passing through **C1 Top Left**. The nylon washers help protect the artwork (decals) from being damaged by the screws.

TAKE GREAT CARE NOT TO PINCH ELECTRICAL WIRES AND CORDS. IF ELECTRICAL WIRES OR CORDS ARE INADVERTENTLY DAMAGED, DO NOT USE THEM! CONTACT MANUFACTURER FOR REPLACEMENT.

Step 10

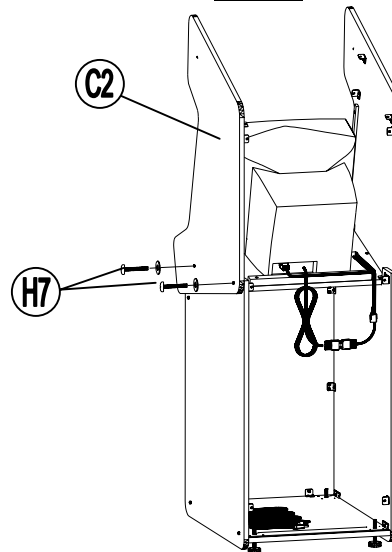

Set **C2 Top Right** on the progressing assembly. The four **H1 Standard Angle Brackets** located on **Top Right** are there only to help position the part while you install **H7 #10-32 x 1-1/4" Truss Head Screws** (no screws will pass through the open holes in the four **H1 Standard Angle Brackets**). Be sure to use **H8 Nylon Washer** on the screws passing through **C2 Top Right**. The nylon washers help protect the artwork (decals) from being damaged by the screws.

TAKE GREAT CARE NOT TO PINCH ELECTRICAL WIRES AND CORDS. IF ELECTRICAL WIRES OR CORDS ARE INADVERTENTLY DAMAGED, DO NOT USE THEM! CONTACT MANUFACTURER FOR REPLACEMENT.

Step 11

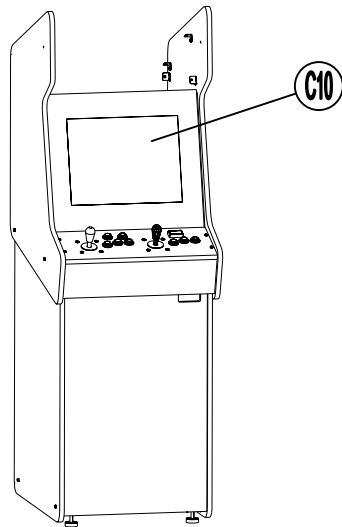

Set **C10 Monitor Glass** in the progressing assembly. The painted side should face toward the inside of the cabinet. The side marked "TOP" should of course be positioned toward the top. The bottom of the glass should sit behind the top of the control panel, which will trap the glass into place.

TAKE GREAT CARE NOT TO PINCH ELECTRICAL WIRES AND CORDS. IF ELECTRICAL WIRES OR CORDS ARE INADVERTENTLY DAMAGED, DO NOT USE THEM! CONTACT MANUFACTURER FOR REPLACEMENT.

Step 12

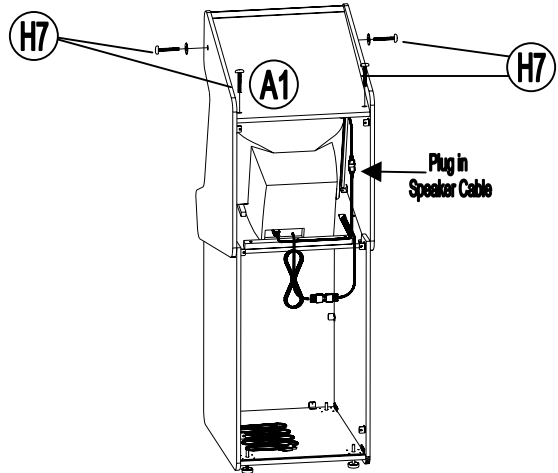

SLOWLY and **CAREFULLY** set **A1 Lightbox Assembly** on top of the progressing assembly being careful not to break **C10 Monitor Glass**. The front of **A1 Lightbox Assembly** should sit in front of the glass and trap it in place. Attach **A1 Lightbox Assembly** with **H7 #10-32 x 1-1/4" Truss Head Screws**. Be sure to use **H8 Nylon Washer** on the screws passing through **C2 Top Right** and **C1 Top Left**. The nylon washers help protect the artwork (decals) from being damaged by the screws. Connect the Speaker Cable, which extends from **A1 Lightbox Assembly** to the remaining cable extending from **A2 Control Panel Assembly**.

TAKE GREAT CARE NOT TO PINCH ELECTRICAL WIRES AND CORDS. IF ELECTRICAL WIRES OR CORDS ARE INADVERTENTLY DAMAGED, DO NOT USE THEM! CONTACT MANUFACTURER FOR REPLACEMENT.

Step 13

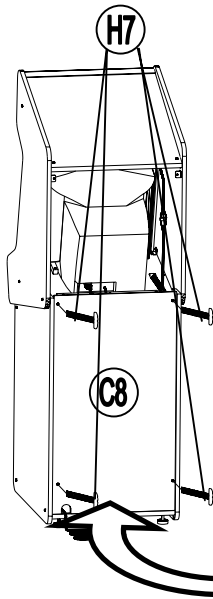

Attention Required!

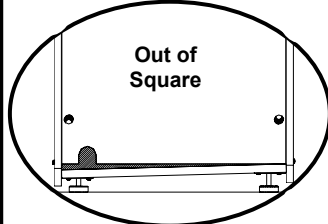

If the unit is not square, **C8 Base Back** will not fit properly. Make sure leg levelers are adjusted properly, loosen screws and force the unit square.

Set **C8 Base Back** in the progressing assembly. Make sure **E2 A/C Cord** passes through the opening in the lower left corner of **C8 Base Back**. Secure **C8 Base Back** with four **H7 #10-32 x 1-1/4" Truss Head Screws**.

TAKE GREAT CARE NOT TO PINCH ELECTRICAL WIRES AND CORDS. IF ELECTRICAL WIRES OR CORDS ARE INADVERTENTLY DAMAGED, DO NOT USE THEM! CONTACT MANUFACTURER FOR REPLACEMENT.

Step 14

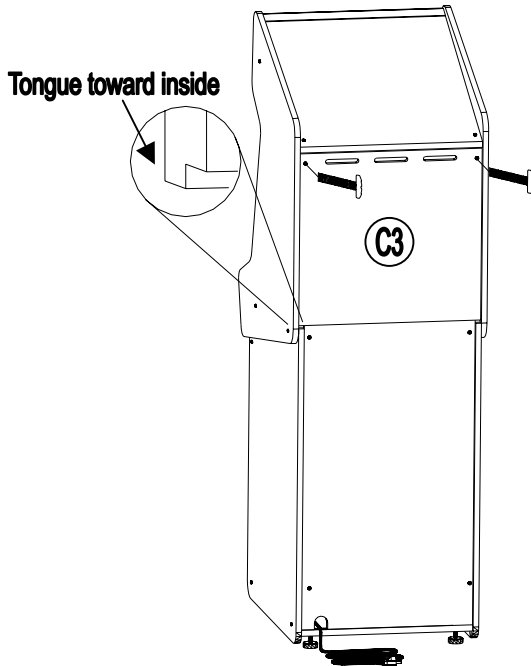

Set **C3 Top Back** in the progressing assembly. Be sure to position the ventilation slots toward the top and the tongue toward the inside of the cabinet. Attach with **H7 #10-32 x 1-1/4" Truss Head Screws**.

TAKE GREAT CARE NOT TO PINCH ELECTRICAL WIRES AND CORDS. IF ELECTRICAL WIRES OR CORDS ARE INADVERTENTLY DAMAGED, DO NOT USE THEM! CONTACT MANUFACTURER FOR REPLACEMENT.

4.5 KEY FEATURES

The locations of the On/Off Switch, Service Button, and Display Adjustment Panel are shown in the illustration below.



The Player 1 joystick is used to navigate the Game Select Screen and Service Menu

Player 1 and Player 2 buttons are used to start a single or two player game

Button 1 is used to make selections in the Service Menu

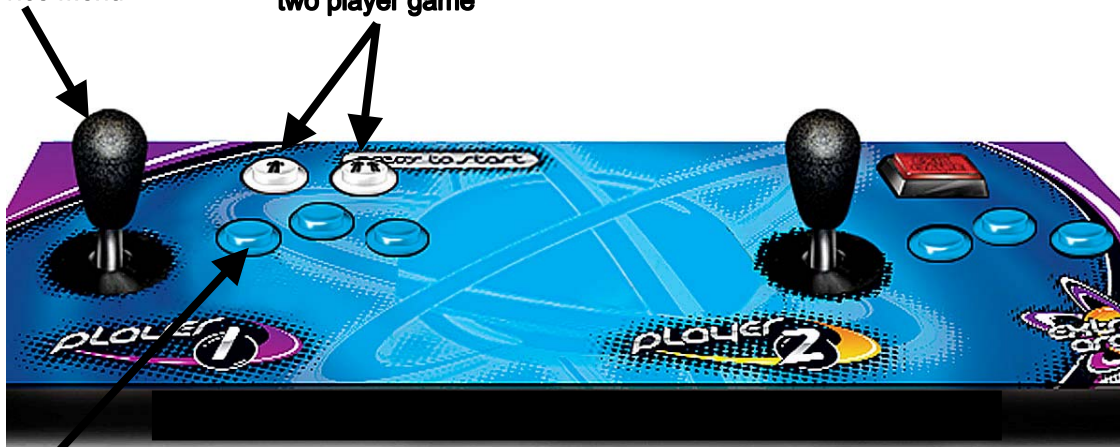

5. SERVICE MENU

Press the **Service Button**, which is located underneath the control panel, just next to the power switch.

The **Service Menu** provides access to **Main Volume** control, the **Game Settings** sub-menu, the **Controller Tests** sub-menu, **Display Convergence Test**, **Display Color Test**, and the **Demo Mode Settings** sub-menu. To change the main volume, use the joystick on the ***Player One*** side (left joystick) to highlight **Main Volume**, and then move joystick right to turn the volume up, or left to turn the volume down. To select any of the other options on screen, highlight using the joystick, and press button 1 (the furthest left blue button) on the ***Player One*** side (left side).

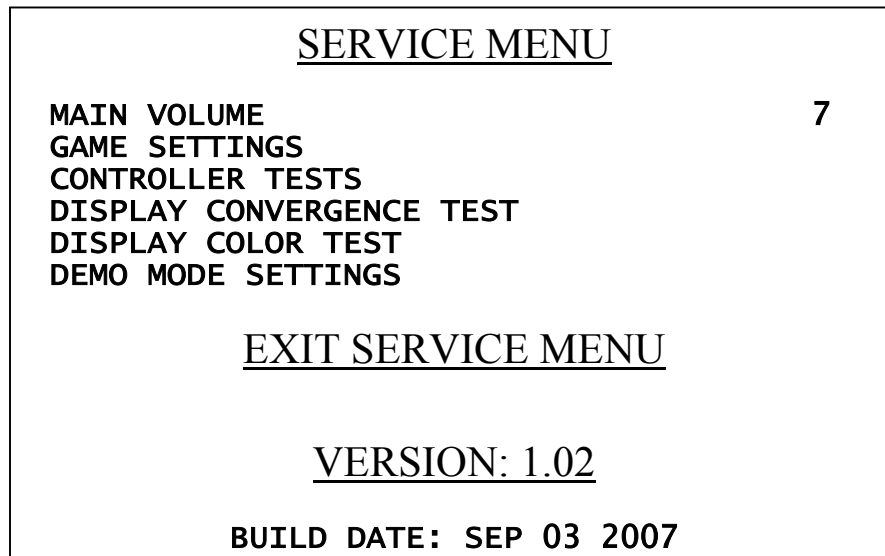

5.1 GAME SETTINGS SUB-MENU

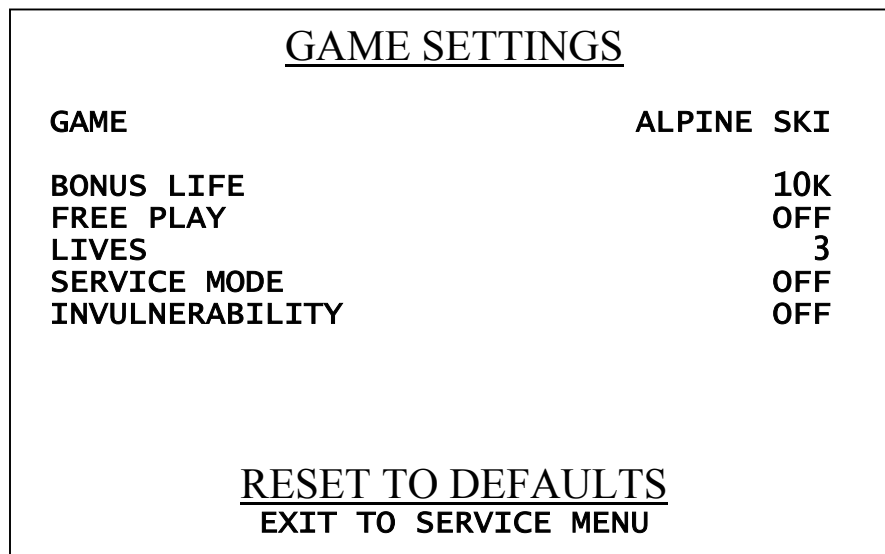

The **Game Settings** sub-menu allows adjustments of several different aspects of game play. Optional settings differ between games. Note: Alpine Ski is shown on the previous page as an example. To select the game for which settings are being adjusted, highlight **GAME** with the joystick on the ***Player One*** side and move the joystick right or left to choose a game. To change the settings, such as how many points are required for a bonus life, or with how many lives a player begins, highlight the specified option with the joystick, and move joystick right or left to choose different settings.

5.2 Controller Tests

The **CONTROLLER TESTS** sub-menu allows you to confirm the buttons and joysticks are functioning correctly. Use of any of the controls should highlight the button or direction pressed in the menu shown below. Should any control cease to work, contact technical support. Each of the controls can be replaced in a matter of minutes with only a Phillips head screwdriver and a nut driver. To exit **CONTROLLER TESTS**, press ***Player 1 Start*** and ***Player 2 Start*** and the same time.

<u>CONTROLLER TESTS</u>		
<u>PLAYER 1</u>	<u>PLAYER 2</u>	<u>GENERAL</u>
UP	UP	MENU
DOWN	DOWN	TEST
LEFT	LEFT	
RIGHT	RIGHT	
BUTTON 1	BUTTON 1	
BUTTON 2	BUTTON 2	
BUTTON 3	BUTTON 3	
START P1	START P2	
P1 AND P2 START EXITS		

5.3 Display Convergence Test

Selecting this option displays a test pattern, which assists in adjusting the monitor.

5.4 Display Color Test

This option displays a color test, which assists in adjusting the monitor.

5.5 Demo Mode Settings

When a game has not been selected from the main menu, the machine runs **DEMO MODE**. In demo mode, the menu automatically cycles through the games, highlighting each for a set period of time. The **DEMO MODE** sub-menu accesses adjustments to this mode. To change settings in **DEMO MODE**, highlight any option with the left joystick, and move joystick right or left to toggle between choices. To return to the main menu, select **EXIT DEMO MODE MENU** with the joystick, and press button 1 (the far left blue button).

<u>DEMO MODE SETTINGS</u>	
DEMO MODE	ENABLED
DEMO MODE VOLUME	7
GAME IDLE TIME	2 MINUTES
MENU IDLE TIME	15 SECONDS
 <u>EXIT DEMO MODE MENU</u>	

6. SELECTING GAMES

To select a game, move the Player 1 joystick up or down to highlight a game. Once you have highlighted the game that you wish to play, press the *Player 1 Start Button* if you wish to start a single player game, or press the *Player 2 Start Button* if you wish to start a game for two players.



Press to Start
a single player
Game



Press to Start
a Two Player
Game

7. GAME CONTROLS INSTRUCTIONS

The GAME CONTROLS screen is displayed before the start of each game. This screen explains which controls are utilized in each game. To exit this screen before the default allotted time, press any button.



8. EXITING A GAME

To exit a game, press the **GAME EXIT** button, which is located on the upper right hand corner of the control panel.

9. TECHNICAL SUPPORT

Free telephone support is provided for the *Extreme Arcade* system. Technical Support is available from 9:00-5:00 Central Time, Monday through Friday. Call 1(800)379-9776. Select technical support in phone system menu.

10. GAMEPACK (UPGRADES)

Please note, *Extreme Arcade* is not compatible with UltraCade/Global VR gamepacks. UPGRADES FOR **ULTIMATE ARCADE** WILL NOT WORK WITH **EXTREME ARCADE!!!**

11. FCC COMPLIANCE

Note: This equipment has been tested and found to comply with the limits for a Class B digital device, pursuant to Part 15 of the FCC Rules. These limits are designed to provide reasonable protection against harmful interference in a residential installation. This equipment generates, uses and can radiate radio frequency energy and, if not installed and used in accordance with the instructions, may cause harmful interference to radio communications. However, there is no guarantee that interference will not occur in a particular installation. If this equipment does cause harmful interference to radio or television reception, which can be determined by turning the equipment off and on, the user is encouraged to try to correct the interference by one of more of the following measures:

--Reorient or relocate the receiving antenna.

--Increase the separation between the equipment and receiver.

--Connect the equipment into an outlet on a circuit different from that to which the receiver is connected.

--Consult the dealer or an experienced radio/technician for help.

Changes or modifications not expressly approved in writing by Chicago Gaming Company could void the user's authority to operate the product.

